



## LABEL PRINTING SCALE

Easy to use

# Now Ethernet Interface



**LSQ  
MODEL**

The fastest way to label your items through an easy programming, controlling your sales and business operations.

- 300 programmable PLU's, option to extend 10,000 products.
- Up to 20 Sellers.
- 72 programmable direct access keys
- Advertising LCD display, back light included.
- Stainless steel construction
- Ethernet connection.

### SCALENET SOFTWARE INCLUDED



### OPTION TO PRINT DIFFERENT PAPER FORMATS

CUSTOM HEADING		
WEIGHT	PRICE \$	TOTAL \$
T-BONE 0.610lb	\$ 2.08	1.27
SIRLOIN 0.735lb	\$ 1.59	1.17
	\$	2.44
CASH	\$	10.00
CHANGE	\$	7.56

2001002058752  
THANK YOU AND COME AGAIN

Continuous paper 2.2" / 56 mm with or without adhesive

MY SHOP		
FRUIT CAKE		
FLOUR, EGG, SUGAR, BUTTER, BAKING POWDER, MILK, WHIPPED CREAM & FRUITS		
PACKED ON 17/04/99	PRICE SLB \$ 2.00	SALE BY 27/04/99 TOTAL \$ \$ 4.00
NET WEIGHT 2 lbs		
2123456010953 KEEP REFRIGERATED		

48 x 38 mm / 1.8" x 1.49" Label

56 x 40 mm / 2.2" x 1.57" Label

Two standard formats, option to personalized choosing continuous paper or label, setting the desire information on it, including bar code.

LSQ	
Capacity	20 kg / 40 lbs
Minimum division	0.005 kg / .01 lb
Weighed minimal unit	100 g / .02lb
Programmable memories	300 (Up to 10,000 memories optional)
Backlight	Included
Power Input	110 v/60 Hz (220 v/ 50 Hz Optional)
Adaptor	Included
Plate	15 X 12 " (38 x 30 cm)
Maximum tare	10 kg/20lb
Price lb/max	999.99 (99.999 optional)
Price \$/max	9999.99 (999.999 optional)
Range of operation temp	- 10 a 40° C (14 a 104 °F)
Renge of Storage temp	- 20 a 50°C (-4 a 122°F)
Net weight	33.51 lb/ 15.2 kg
Shipping weight	43.21 lb/ 19.6 kg

Includes:  
 1 cartridge  
 1 Set of 2 keys for programming access  
 1 paper roll  
 1 label roll  
 1 Serial cable for PC communication  
 User manual  
 1 CD containing Scalenet software, Scalenet manual and Programming manual  
 1 Easy-to-program stencil  
 1 AC Adaptor 120 Vac input, 24 Vac output, 3A

Program the LSQ according to your needs!

The LSQ-40L can be set up in two different ways:

#### Direct Programming

Option to enter 72 most used items through the programming keypad, just entering product name followed by the price and the assigned key access. For more information please read the easy programming instructions described inside this brochure.

OR

#### Key programming/Software programming\*

The LSQ 40L can also be programmed through the access key (direct to the scale) or SCALENET software (from PC). SCALENET and key programming manuals are included on the cd.

The following programmable features are available:

- 300 - 10,000 PLU's memories.
- Printing formats and personalizad formats.
- Label's Headlines
- Option to enter ingredients
- Scrolling promotion messages
- Configure cash register functions, returns, discounts and non weighed products.
- Programming Bar code.
- 72 direct access memory keys through the keypad included.
- Up to 20 programmed sellers
- Printable lists and sales reports
- Etc

**\*Custom programming has to be done to meet customer needs and can be done by the customer or by the dealer. Custom programming is not included in the product price.**

### DIMENSIONS

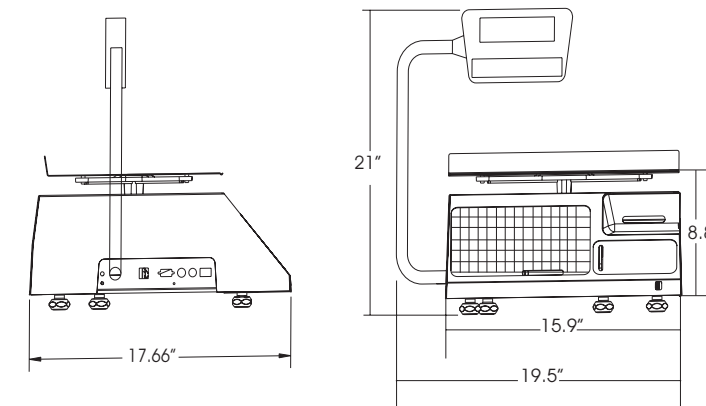

EXPANSION MEMORY BOARD TO 10,000 PLU's  
 With the expansion memory board you can up the PLU from 300 to 10,000 PLU's. (optional accessory, not included)



NTEP CC No. 00-135A1  
 \*Available only in equipment ordered under this spec

DISTRIBUTED BY

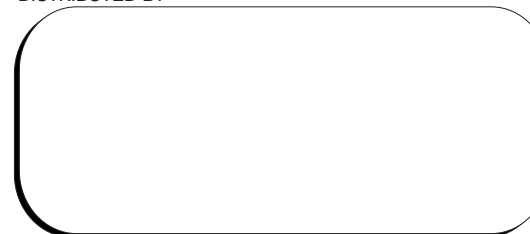

ALL INFORMATION IS SUBJECT TO CHANGE WITHOUT NOTICE

## DIRECT AND EASY PROGRAMMING



Press ABC key.

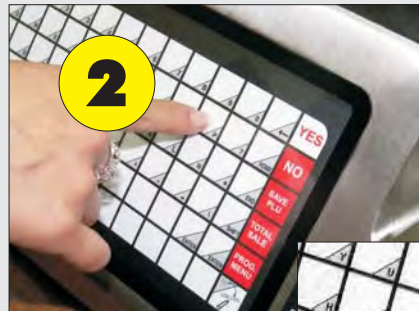

Type the product name.



Press ENTER key.



Type product price and press ENTER key.

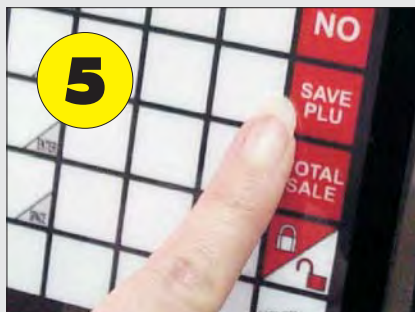

Press "SAVE PLU" key, then assign the product on the memory-key you want to set the product, you can chose any of the 72 direct access.

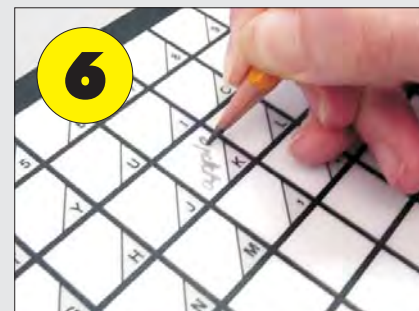

Remove the plu's stencil and write the name of the product.

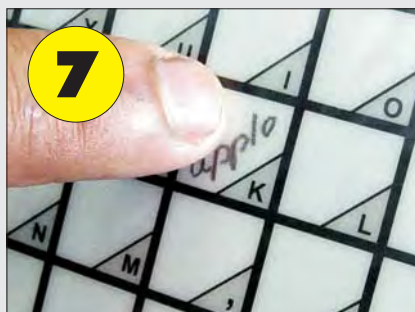

Press the saved PLU



Press "PRINT" key to get the label.

## PROGRAMMABLE FEATURES AVAILABLE

- 300 to 10000 PLU's
- Customized printing format
- Ingredients
- Advertising Message
- Returns, discounts and cash register functions for non weighed products
- Bar code UPC or EAN Programming
- 72 direct access keys
- 20 sellers.
- Different printing reports
- Etc.

## MULTIPLE TYPES OF SALES REPORTS

You can get list and sales reports, which will help you on the administration of your business, such as:

- |                           |                  |
|---------------------------|------------------|
| Reports                   | Lists            |
| - Sales by seller         | - General PLU's  |
| - Sales by PLU's          | - Tares List     |
| - Sales by PLU's group    | - Sellers list   |
| - Sales by seller's group | - By group       |
| - Sales by department     | - By Department. |
| - Sales by group          |                  |

## HIGH PRECISION

LSQ minimum division to .01 lb on 40 lbs capacity.

## ETHERNET CONNECTION



Includes Software

SCALENET software included for its configuration from a computer.

An unlimited number of LSQ scales can be installed into a local red.

Sales can be controlled for each scale or group of scales.

## EASY-TO-CHANGE CARTRIDGE

The easy-to-change cartridge and its larger label roll capacity (1,500 labels per roll) expedites customer service and reduces downtime by having always a spare cartridge to preload it at non-busy times.



## PRINTING FORMAT SELECTOR

Printing format selector permits to change easily from one printing format to another making this operation quick and easy.

## SECURITY KEY CONTROL

Its security system avoids the modification of the program by any unauthorized person. The access is limited in two security levels. First, the supervisor level which, through password, is able to give discounts, to make returns, to add new products, etc; Second the Manager level, which only can be accessed by the security key and a password.

In this mode you are able to modify the general configuration of the scale, such as password, labels, reports, lists, price, etc.



## PROGRAM SCROLLING PROMOTIONAL

Two Sided LCD display for customer and operator view, increase buyer confidence, simplify operations and reduces mistakes.

Easy-to-read display indicate weight and prices, and scroll promotional messages.

## STAINLESS STEEL CABINET AND PLATE

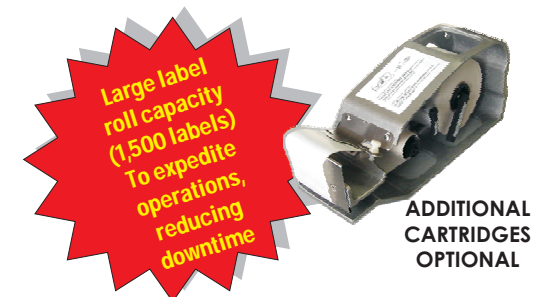

ADDITIONAL CARTRIDGES OPTIONAL

## USER-FRIENDLY KEYBOARD

The user-friendly keyboard design requires no complicated training of in-store personnel. It features 72 direct access memory keys for quick access to fast moving products and up to 10,000 memory keys ensure all products sold are labeled and not under nor overpriced and eliminates pricing errors during checkout.



## CONNECTION PANEL ON LH SIDE

